

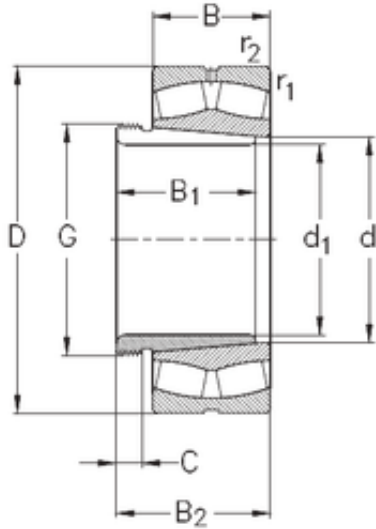

NTN DRIVESHAFT ANDERSON, INC.



300 mm x 460 mm x 160 mm NKE
24060-K30-MB-W33+AH24060 spherical roller bearings

Bearing No. 24060-K30-MB-W33+AH24060

24060-K30-MB-W33+AH24060 Bearing 2D drawings and 3D CAD models

Size	300x460x160 mm
Bore Diameter	300 mm
Outer Diameter	460 mm
Width	160 mm
d	300 mm
d1	280 mm
D	460 mm
B	160 mm
C	160 mm
r1 min.	4 mm
r2 min.	4 mm
B1	184 mm
B2	202 mm
C	24 mm
Thread (G)	Tr 310x5
Weight	131,5 Kg
Basic dynamic load rating (C)	2432 kN
Basic static load rating (C0)	4920 kN
Limiting speed	1200 r/min
Calculation factor (e)	0,32
Calculation factor (Y0)	2,07
Calculation factor (Y1)	2,12