

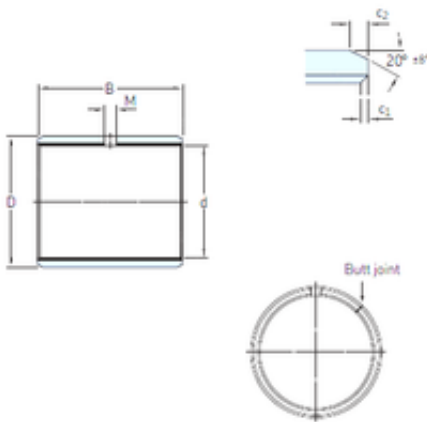

NTN DRIVESHAFT ANDERSON, INC.

10 mm x 12 mm x 8 mm SKF PCM 101208 E
plain bearings



Bearing No. PCM 101208 E

Size	10x12x8 mm
Bore Diameter	10 mm
Outer Diameter	12 mm
Width	8 mm
d	10 mm
D	12 mm
B	8 mm
c1 min	0,1 mm
c2 min	0,2 mm
M	– mm
Weight	0,002 Kg
Basic dynamic load rating (C)	6,4 kN
c ₁ min.	0.1 mm
c ₁ max.	0.6 mm
c ₂ min.	0.2 mm
c ₂ max.	1 mm
± 8	20 °
Tolerance shaft	f7
Tolerance housing	H7
Basic dynamic load rating - radial direction C	6.4 kN
Basic static load rating - radial direction C ₀	20 kN
Specific dynamic load factor K	80 N/mm ²
Specific static load factor K ₀	250 N/mm ²

PCM 101208 E Bearing 2D drawings and 3D CAD models



NTN DRIVESHAFT ANDERSON, INC.

Factor depending on material and bearing type K_M	480
Permissible sliding velocity v min.	0 m/s
Permissible sliding velocity v max.	2 m/s
Coefficient of friction μ min.	0.03
Coefficient of friction μ max.	0.25
Mass bushing	0.002 kg